

PSTricks

pst-shell

Plotting sea shells; v.0.03

December 27, 2016

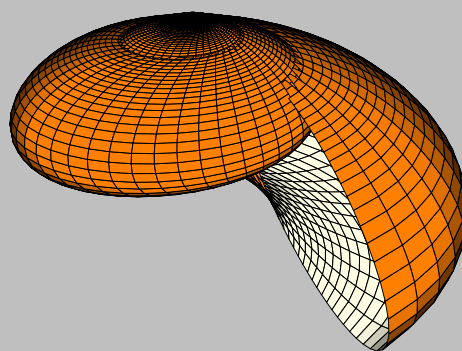

Package author(s):
Manual Luque
Herbert Voß

Contents

1	Les équations	3
2	Le package pst-shell	3
3	Syntax	4
4	Predefined styles	4
5	Les motifs colorés qui ornent les coquillages	18
6	Shells created with a data file	19
7	Saving data to external files	24
8	List of all optional arguments for pst-shell	25
	References	25

1 Les équations

La modélisation géométrique des coquillages a été réalisée par M. B. Cortie. Dans le document "DIGITAL SEASHELLS" il en donne les équations paramétriques lesquelles sont fonction de 14 paramètres, ceci afin de permettre de modéliser un très grand nombre de coquillages.

https://www.researchgate.net/publication/223141547_Digital_seashells

$$\begin{cases} x = D[A \sin \beta \cos \theta + R \cos(s + \phi) \cos(\theta + \Omega) - R \sin \mu \sin(s + \phi) \sin(\theta + \Omega)]e^{\theta \cot \alpha} \\ y = D[-A \sin \beta \sin \theta - R \cos(s + \phi) \sin(\theta + \Omega) - R \sin \mu \sin(s + \phi) \cos(\theta + \Omega)]e^{\theta \cot \alpha} \\ z = [-A \cos \beta + R \sin(s + \phi) \cos \mu]e^{\theta \cot \alpha} \end{cases}$$

$$\begin{aligned} R &= R_e + k \\ R_e &= \frac{1}{\sqrt{\frac{\cos^2(s)}{a^2} + \frac{\sin^2(s)}{b^2}}} \\ k &= L \exp \left(- \left[\frac{2(s - P)}{W_1} \right]^2 - \left[\frac{2f(\theta)}{W_2} \right]^2 \right) \\ f(\theta) &= \frac{360}{N} \left(\frac{N\theta}{2\pi} - \text{int} \left(\frac{N\theta}{2\pi} \right) \right) \quad \theta(\text{rd}) \end{aligned}$$

La démonstration de ces équations est proposée par Jorge Picado, elle est très complète et joliment illustrée :

<http://www.mat.uc.pt/~picado/conchas/index.html>

Jorge Picado rajoute le paramètre $D = \pm 1$ permettant ainsi la représentation des coquillages senestre et dextre. Jorge Picado propose un code pour Mathematica, que je n'ai pas pu tester, cependant les images qui illustrent sa page accompagnées des paramètres d'un grand nombre de coquillages sont très démonstratives. Sur le site de l'American Mathematical Society, Tony Phillips et Stony Brook traitent aussi de la modélisation de divers coquillages avec le code pour une concrétisation avec Maple.

<http://www.ams.org/samplings/feature-column/fcarc-shell1>

2 Le package pst-shell

Le package '**pst-shell**' permet de représenter les coquillages avec PSTricks, c'est donc une adaptation des équations établies par M. B. Cortie. Les paramètres utilisés sont identiques à ceux des documents de M. B. Cortie et Jorge Picado. On se référera donc à ces 2 auteurs pour en connaître la signification. On n'aura pas avec PSTricks la rapidité d'affichage de Mathematica et Maple, ni la qualité de lissage des surfaces possible avec ces logiciels ou POV-Ray, mais sur certains exemples, grâce aux options de pst-solides3d, on peut obtenir des représentations personnalisées que je suppose être beaucoup plus difficiles à réaliser avec Maple ou Mathematica, c'est un point qui sera développé avec comme sujet le *Nautilus* dans un autre fichier. Voici la liste de ces paramètres, je donne les valeurs par défaut qui sont celles du *Natica stellata*, Orange Moon (cf. Jorge Picado) :

- $D = 1 : A=25$
- $\alpha=83 : \beta=42 : \mu=10 : \Omega=30 : \text{en degrés}$
- $a=12 : b=20$
- $L=1$
- $P=1$
- $W1=1 : W2=1$
- $N=0$

3 Syntax

```
\psShell [Options] ( $x_0, y_0, z_0$ )
```

x_0, y_0, z_0 is preset to 0, 0, 0.

4 Predefined styles

```
\newsstyle[pst-shell]{Achatina}%
  {D=1,A=109,alpha=86.6,beta=8.5,mu=0,Omega=0,phi=0,a=32,b=48,L=0,P=0,W1=1,W2=1,N=0}
\newsstyle[pst-shell]{Ammonite}%
  {alpha=83,beta=90,phi=1,mu=1,Omega=1,A=2.5,a=1,b=0.9,L=0.5,W1=100,W2=20,P=10,N=15}
\newsstyle[pst-shell]{Argonauta}%
  {alpha=80,beta=90,phi=0,mu=0,Omega=0,A=2,a=2,b=1.5,L=0.3,W1=150,W2=20,P=5,N=30}%
\newsstyle[pst-shell]{Codakia}%
  {alpha=37,beta=90,phi=0,mu=1,Omega=1,A=10500,a=10000,b=10500,L=0,W1=0,W2=0,P=0,N=0}
\newsstyle[pst-shell]{Conus}%
  {D=1,A=7,alpha=87,beta=7,mu=0,Omega=0,phi=78,a=4.3,b=1,L=0,P=0,W1=0,W2=0,N=0}
\newsstyle[pst-shell]{Epiteonium}%
  {D=1,A=9.5,alpha=85.9,beta=9,mu=0,Omega=0,phi=81,a=2.1,b=1.6,L=1.3,P=-60,W1=200,W2=20,N=8.3}
\newsstyle[pst-shell]{Escalaria}%
  {alpha=86,beta=10,phi=45,mu=5,Omega=1,A=90,a=20,b=20,L=14,W1=180,W2=0.4,P=40,N=180}
\newsstyle[pst-shell]{Helcion}%
  {alpha=18,beta=90,phi=0,mu=0,Omega=-40,A=450,a=400,b=310,L=0,W1=0,W2=0,P=0,N=0}
\newsstyle[pst-shell]{Lyria}%
  {D=1,A=50,alpha=83.9,beta=-19,mu=1,Omega=-2,phi=45,a=40,b=14,L=4,P=0,W1=6,W2=27,N=8}
\newsstyle[pst-shell]{Natalina}%
  {alpha=80,beta=40,phi=55,mu=10,Omega=30,A=25,a=12,b=16,L=0,W1=0,W2=0,P=0,N=0}
\newsstyle[pst-shell]{Nautilus}%
  {D=-1,A=2,alpha=80,beta=90,mu=0,Omega=0,phi=0,a=2,b=1.5,L=0,P=0,W1=0,W2=0,N=0}
\newsstyle[pst-shell]{Oxysteles}%
  {D=1,A=47,alpha=84.9,beta=7,mu=0,Omega=0,phi=-36,a=40,b=19,L=0,P=0,W1=1,W2=1,N=0}
\newsstyle[pst-shell]{Planorbis}%
  {alpha=84,beta=85,phi=10,mu=45,Omega=5,A=45,a=20,b=30,L=0,W1=0,W2=0,P=0,N=0}
\newsstyle[pst-shell]{Tonna}%
  {D=1,A=70,alpha=82.4,beta=0,mu=10,Omega=0,phi=0,a=58,b=50,L=0,P=0,W1=1,W2=1,N=0}
\newsstyle[pst-shell]{Turritella}%
  {D=1,A=22.2,alpha=88.9,beta=4,mu=1,Omega=-2,phi=55,a=1.3,b=1.5,L=0,P=0,W1=0,W2=0,N=0}
```

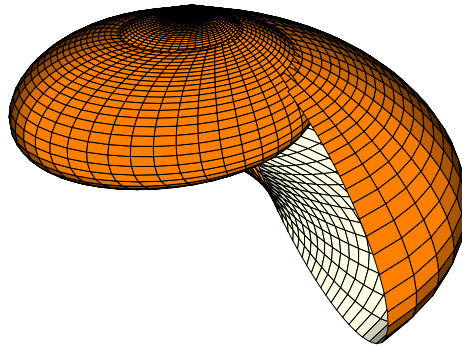

Natica stellata, Orange Moon avec les paramètres de base.

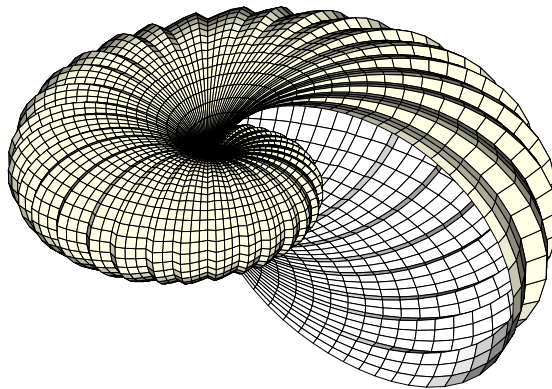
```
\psset[pst-solides3d]{viewpoint=1000 -50 20 rtp2xyz,lightsrc=viewpoint, Decran=25}
\begin{pspicture}(-3,-5)(4,1)
\psShell[ngrid=180 60,fillcolor=orange,incolor=yellow!10,
base=720 -720 -270 90,linewidth=0.01pt]
\end{pspicture}
```

Argonauta

```
\begin{pspicture}(-5,-3)(5,3)
\psset[pst-solides3d]{lightsrc=viewpoint,viewpoint=100 -50 30 rtp2xyz,Decran=120}%
\psShell[style=Argonauta,ngrid=1080 45,incolor=white,
fillcolor=yellow!10,linewidth=0.01,base=0 -3600 -180 180]
\end{pspicture}
```

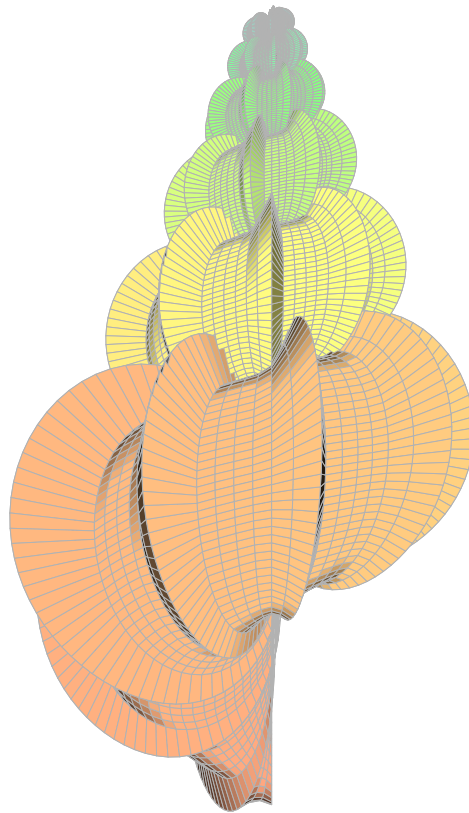
Epiteonium

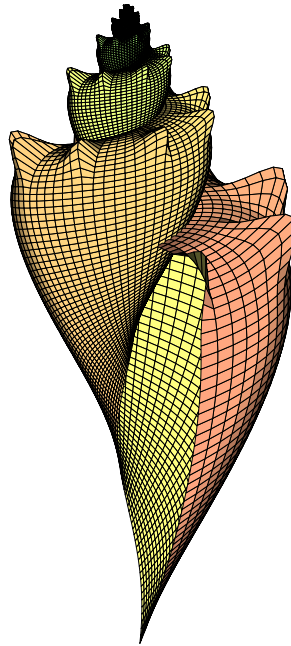

```
\begin{pspicture}(-5,-12)(5,0)
\psset[pst-solides3d]{lightsrc=viewpoint,viewpoint=5000 -180 -10 rtp2xyz,Decran=500}
\psShell[style=Epiteonium,ngrid=360 60,incolor=white,linecolor=black!30,
base=1800 -360 -270 20,hue=0.05 0.5 0.5 1,linewidth=0.001pt]
\end{pspicture}
```

Lyria

```
\psset{unit=1.25cm}
\begin{pspicture}(-3,-7)(3,0)
\psset[pst-solides3d]{lightsrc=viewpoint,viewpoint=10000 -20 10 rtp2xyz,Decran=50}
\psShell[style=Lyria,base=1800 -360 -51 9,ngrid=360 60,incolor=yellow!50,
hue=0.05 0.5 0.5 1,linewidth=0.001pt]
\end{pspicture}
```

Turritella

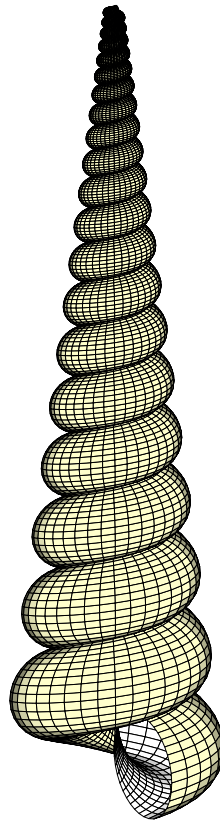

```
\begin{pspicture}(-3,-14)(3,-0.5)
\psset[pst-solides3d]{lightsrc=viewpoint,viewpoint=1000 -30 10 rtp2xyz,Decran=500}
\psShell[style=Turritella,base=0 -7200 -267 39,ngrid=720 30,incolor=white,
fillcolor=yellow!20,linewidth=0.01pt]
\end{pspicture}
```

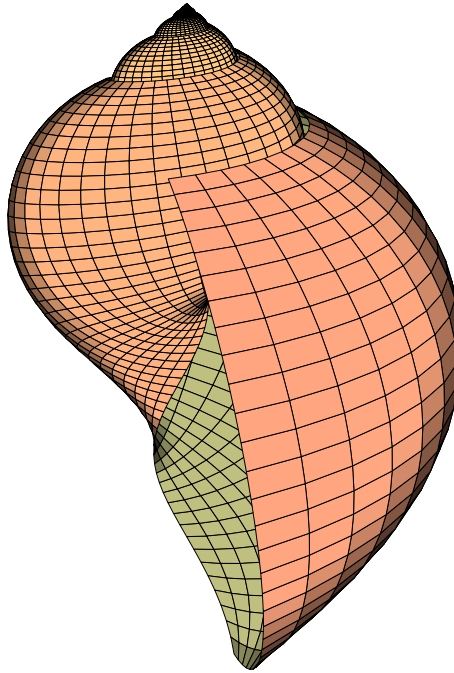
Tonna

```
\begin{pspicture}(-5,-9)(5,1)
\psset[pst-solides3d]{lightsrc=viewpoint,viewpoint=1000 -10 10 rtp2xyz,Decran=75}
\psShell[style=Tonna,base=0 -7200 -90 60,ngrid=720 30,incolor=yellow!50!black!50,
hue=0.05 0.5 0.5 1,linewidth=0.005]
\end{pspicture}
```

Achatina

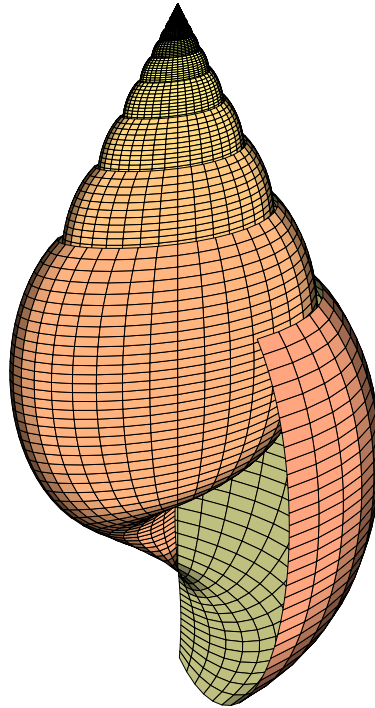

```
\begin{pspicture}(-5,-10)(5,1)
\psset[pst-solides3d]{lightsrc=viewpoint,viewpoint=1000 -30 10 rtp2xyz,Decran=60}
\psShell[style=Achatina,base=0 -7200 -110 65,ngrid=720 36,incolor=yellow!50!black!50,
hue=0.05 0.5 0.5 1,linewidth=0.005]
\end{pspicture}
```

Oxysteles

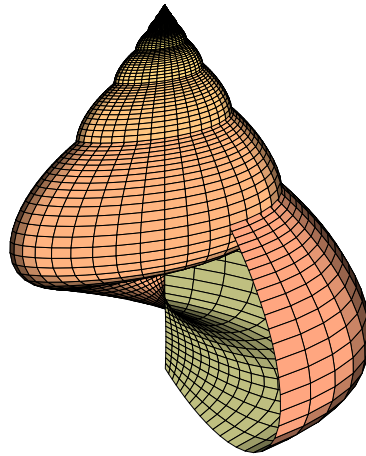

```
\begin{pspicture}(-5,-7)(5,1)
\psset[pst-solides3d]{lightsrc=viewpoint,viewpoint=1000 -30 10 rtp2xyz,Decran=75}
\psShell[style=Oxysteles,base=0 -7200 -70 70,ngrid=720 36,incolor=yellow!50!black!50,
hue=0.05 0.5 0.5 1,linewidth=0.005]
\end{pspicture}
```

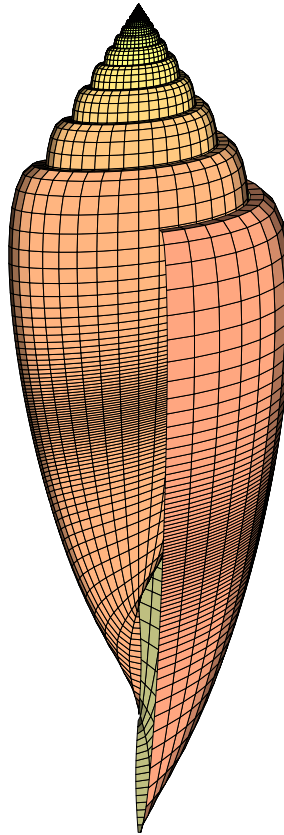
Conus

```
\begin{pspicture}(-3,-13)(3,1)
\psset[pst-solides3d]{lightsrc=viewpoint,viewpoint=1000 -10 10 rtp2xyz,Decran=1000}
\psShell[style=Conus,base=0 -7200 -180 2,ngrid=720 72,incolor=yellow!50!black!50,
hue=0.05 0.5 0.5 1,linewidth=0.005]
\end{pspicture}
```

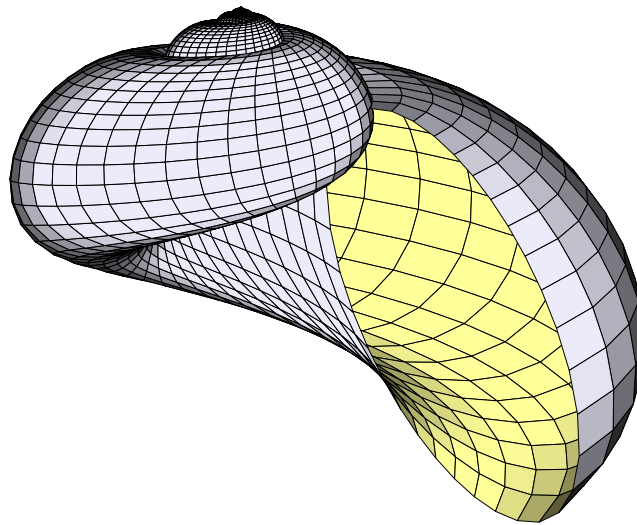
Natalina

```
\begin{pspicture}(-3,-7)(6,0)
\psset[pst-solides3d]{lightsrc=viewpoint,viewpoint=1000 -60 10 rtp2xyz,Decran=200}
\psShell[style=Natalina,base=0 -7200 -270 62,ngrid=720 30,incolor=yellow!40,
fillcolor=yellow!20!blue!10,linewidth=0.01pt]
\end{pspicture}
```

Planorbis

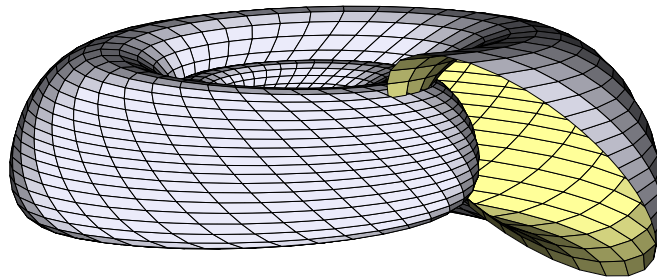

```
\begin{pspicture}[showgrid=false](-4,-3)(6,2)
\psset[pst-solides3d]{lightsrc=viewpoint,viewpoint=1000 -60 10 rtp2xyz,Decran=80}
\psShell[style=Planorbis,base=0 -7200 -150 130,ngrid=720 30,incolor=yellow!40,
fillcolor=yellow!20!blue!10,linewidth=0.01pt]
\end{pspicture}
```

Ammonite

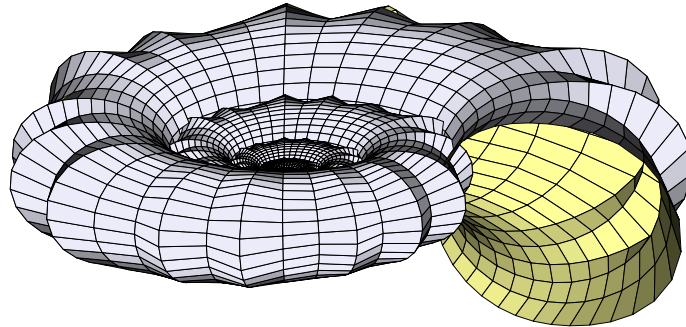

```
\begin{pspicture}[showgrid=false](-4,-2)(6,3)
\psset[pst-solides3d]{lightsrc=viewpoint,viewpoint=100 -60 20 rtp2xyz,Decran=150}
\psShell[style=Ammonite,base=0 -7200 -170 170,ngrid=720 30,incolor=yellow!40,
fillcolor=yellow!20!blue!10,linewidth=0.01pt]
\end{pspicture}
```

Helcion

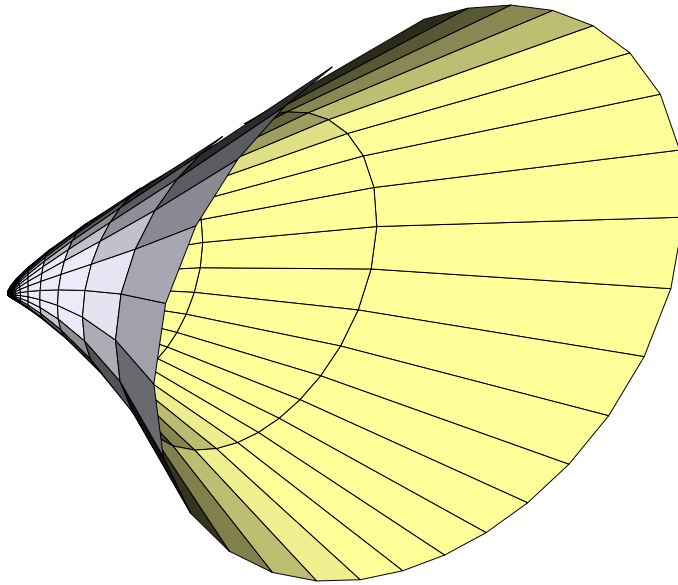

```
\begin{pspicture}[showgrid=false](-1,-4)(10,4)
\psset[pst-solides3d]{lightsrc=viewpoint,viewpoint=4000 -90 20 rtp2xyz,Decran=50}
\psShell[style=Helcion,base=0 -7200 -180 180,ngrid=720 30,incolor=yellow!40,
fillcolor=yellow!20!blue!10,linewidth=0.01pt]
\end{pspicture}
```

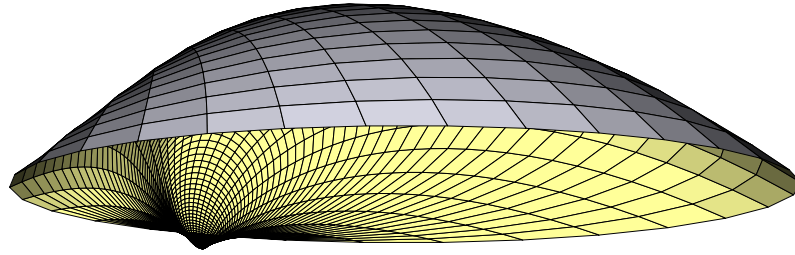
Codakia

```
\begin{pspicture}[showgrid=false](-3,-1)(8,3)
\psset[pst-solides3d]{lightsrc=viewpoint,viewpoint=1.e6 -30 -10 rtp2xyz,Decran=500}
\psShell[style=Codakia,base=0 -2000 -180 180,ngrid=720 30,incolor=yellow!40,RotX=90,%RotY=90,
fillcolor=yellow!20!blue!10,linewidth=0.01pt]
\end{pspicture}
```

Escalaria

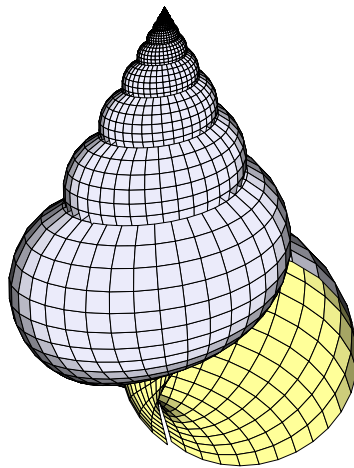

```
\begin{pspicture}[showgrid=false](-3,-7)(3,0)
\psset[pst-solides3d]{lightsrc=viewpoint,viewpoint=800 -90 20 rtp2xyz,Decran=50}
\psShell[style=Escalaria,base=0 -7200 -180 180,ngrid=720 30,incolor=yellow!40,
fillcolor=yellow!20!blue!10,linewidth=0.01pt]
\end{pspicture}
```

5 Les motifs colorés qui ornent les coquillages

Hans Meinhardt a mis au point les équations des réactions de diffusion activateur-inhibiteur permettant la simulation des motifs colorés d'un grand nombre de coquillages. Son livre : *"The Algorithmic Beauty Of Sea shell"* contient toutes les équations avec les photographies des coquillages et un CD avec un programme de simulation. C'est évidemment la partie la plus difficile à faire, non pas tellement la réalisation des motifs mais leur application sur la forme du coquillage correspondant. Randolph Schultz a réussi à conjuguer les 2 parties : géométrie et motifs du coquillage :

<http://www.shelly.de/>

C'est un shareware, mais le programme est utilisable sans achat, il ne permet pas alors la sauvegarde des réalisations.

L'exemple suivant essaye de se rapprocher des motifs du Nautilus. D'autres façons de représenter le nautilus sont étudiées dans le fichier dédié.

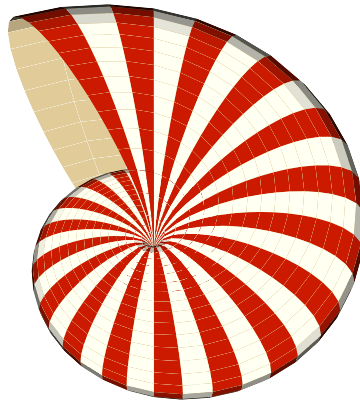

```
\begin{pspicture}(-3,-3)(4,4)
\psset[pst-solides3d]{lightsrc=viewpoint,viewpoint=50 -30 60 rtp2xyz,Decran=50}
\psShell[style=Nautilus,base=0 -3600 180 -180,ngrid=360 36,unit=1,incolor=beige,
fillcolor=yellow!5,linewidth=0, fcol=0 72 360 36 2 div mul cvi 36 sub
{ dup 1 exch 36 add { (0.8 0.1 0 setrgbcolor)} for} for]
\end{pspicture}
```

6 Shells created with a data file

```
\psShell[file=data/nautile-360-36,...]
```

afin de procéder aux transformations souhaitées.

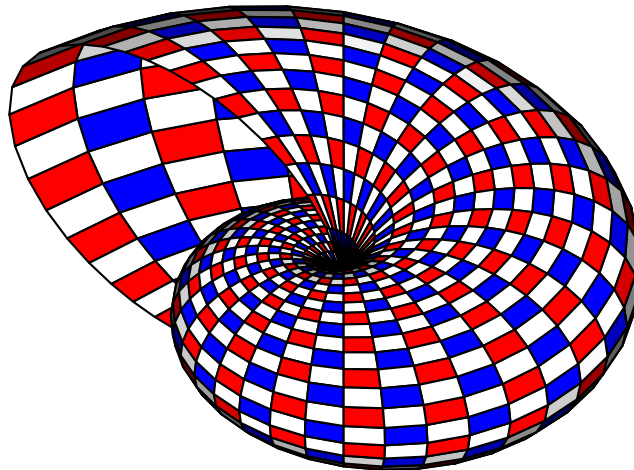

```
\psset{unit=1.5}
\begin{pspicture}(-3.5,-2)(3.5,3)
\psset{lightsrc=viewpoint,viewpoint=50 -50 40 rtp2xyz,Decran=50,solidmemory}
\psShell[file=data/nautile-360-36,incolor=white,
fcol= 0 72 360 71 mul { dup 2 exch 36 add
{ dup (rouge) exch 37 add (blue)} for} for]
\end{pspicture}
```

Dans de deuxième dessin, on va ajouter la coquille en supprimant une facette sur deux. La commande [rm=numéros des faces à supprimer] de pst-solides3d devrait pouvoir le faire, mais ayant constaté quelques dysfonctionnements avec celle-ci, je supprime directement les facettes avec une macro postscript, puis on enregistre le fichier pour l'utiliser à nouveau sans refaire les calculs :

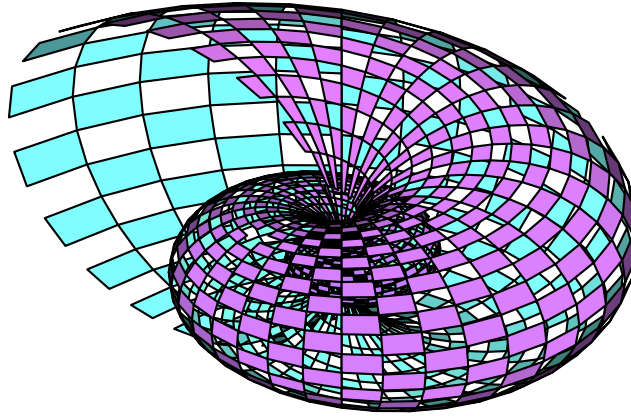

```
\psset{unit=1.5}
\begin{pspicture}(-4,-2)(3,3)
\psset{lightsrc=viewpoint,viewpoint=50 -50 30 rtp2xyz,Decran=50,solidmemory}
\psShell[file=data/testnautil-360-36,deactivatecolor]
\end{pspicture}
```

On supprime les facettes directement avec la commande [rm], ce qui est bien plus long!

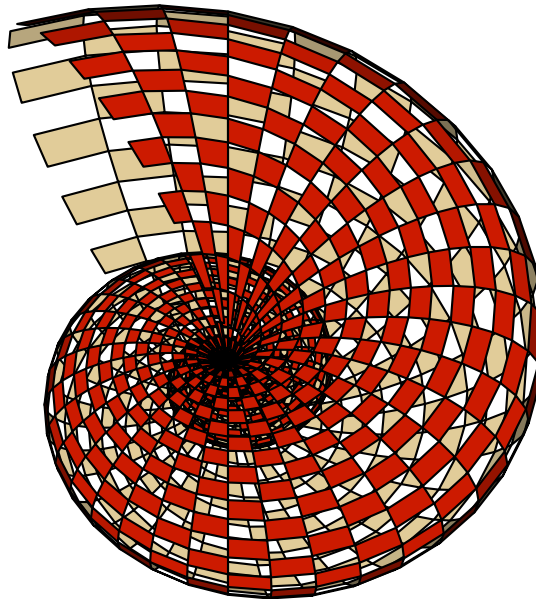

```
\psset{unit=1.5}
\begin{pspicture}(-3,-3)(4,4)
\psset{lightsrc=viewpoint,viewpoint=50 -30 60 rtp2xyz,Decran=50,solidmemory}
\psShell[file=data/nautilus-360-36,deactivatecolor,rm= 0 72 360 71 mul {/i exch def i 2 i 36 add
{/j exch def j j 37 add} for} for]
\end{pspicture}
```

On change la définition 180×24 et on enregistre le fichier.

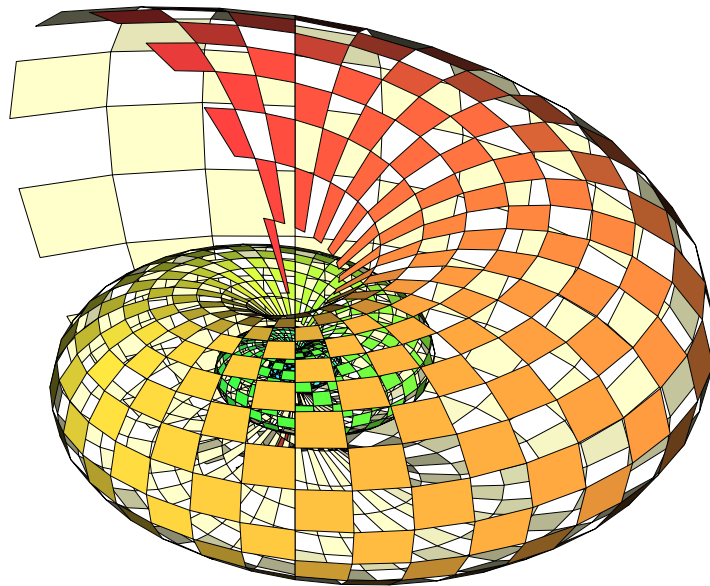

```
\psset{unit=2cm}
\begin{pspicture}(-3,-2)(4,3)
\psset{lightsrc=viewpoint,viewpoint=50 -30 30 rtp2xyz,Decran=50}
\psShell[file=data/nautilus-180-24,deactivatecolor,linewidth=0.001,
  precode=/n1 180 def /n2 24 def /n1n2 n1 n2 2 mul 1 sub mul def /step n2 2 mul def,
  rm= 0 step n1n2 { dup 2 exch n2 add
    { dup n2 add 1 add} for} for]
\end{pspicture}
```

D'autres variantes pour coloriser le coquillage.

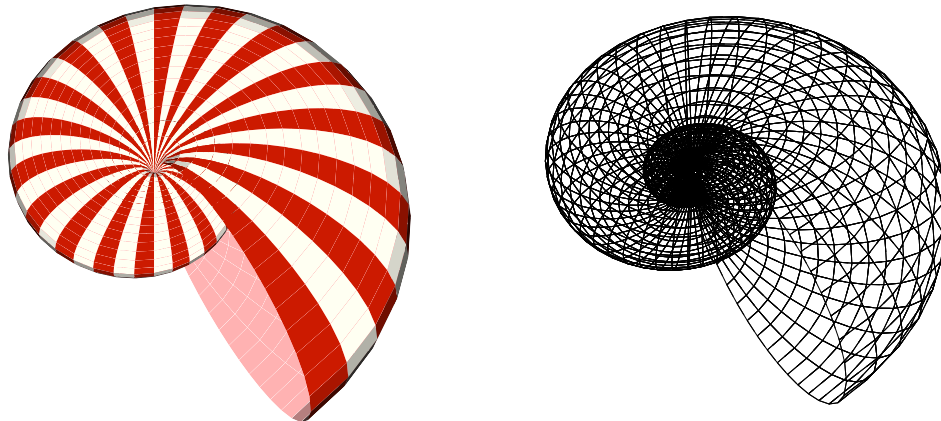

```

\begin{pspicture}(-3,-4)(4,3)
\psset{lightsrc=viewpoint,viewpoint=50 -30 60 rtp2xyz,Decran=50}
\psShell[style=Nautilus,D=1,base=0 -3600 -180 180,ngrid=360 36,incolor=red!30,
fillcolor=yellow!5,linewidth=0,
fcol=0 72 360 36 2 div mul cvi 36 sub { dup 1 exch 36 add
{ (0.8 0.1 0 setrgbcolor) } for } for]
\end{pspicture}
\begin{pspicture}(-3,-4)(4,3)
\psset{viewpoint=100 -30 50 rtp2xyz,Decran=100}
\psShell[style=Nautilus,D=1,base=0 -720 -180 180,ngrid=90 36,linewidth=0.01pt,action=draw]
\end{pspicture}

```

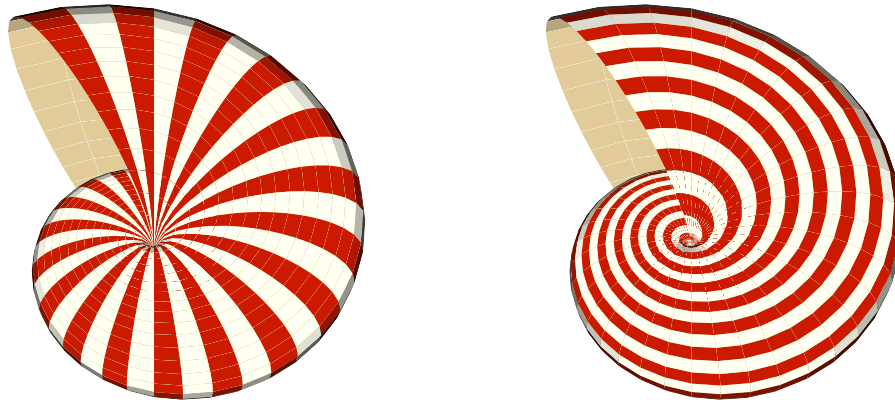

```

\begin{pspicture}(-3,-3)(4,4)
\psset{lightsrc=viewpoint,viewpoint=50 -30 60 rtp2xyz,Decran=50}
\psShell[style=Nautilus,base=0 -3600 180 -180,ngrid=360 36,incolor=beige,
fillcolor=yellow!5,linewidth=0,fc0l=0 72 360 36 2 div mul cvi 36 sub
{ dup 1 exch 36 add { (0.8 0.1 0 setrgbcolor)} for} for]
\end{pspicture}
\begin{pspicture}(-3,-3)(4,4)
\psset{lightsrc=viewpoint,viewpoint=50 -30 60 rtp2xyz,Decran=50}
\psShell[style=Nautilus,base=0 -3600 180 -180,ngrid=360 36,incolor=beige,
fillcolor=yellow!5,linewidth=0,fc0l=0 2 360 36 2 div mul cvi 2 sub
{ (0.8 0.1 0 setrgbcolor)} for]
\end{pspicture}

```

7 Saving data to external files

With the optional argument `writedata` one can save the data in external files. The shell itself is not plotted.

```
\psShell[writedata,file=data/myShell,...]
```

Subdirectories must exist, otherwise the package throws an error on PostScript level. The external files are created with either a Ghostscript run `gs <file>.ps` or when converting the file to pdf. The example:

```

\begin{pspicture}(-4,-4)(4,4)
\psset{lightsrc=viewpoint,viewpoint=10 -20 0 rtp2xyz,Decran=10}
\psset{style=Nautilus,A=0.5,alpha=45,beta=90,a=0.5,b=0.75}
\psShell[writedata,file=data/cockle,
base=0 -3600 -180 200,
ngrid=360 36,unit=4cm,linewidth=0.001,RotX=-90,incolor=white,fillcolor=white,
fc0l=0 2 360 36 2 div mul cvi 2 sub { (0.8 0.1 0 setrgbcolor)} for
360 36 mul cvi 2 360 36 mul 2 mul 2 sub { (0 0 0.8 setrgbcolor)} for]
\end{pspicture}

```

creates four files in the subdirectory `data/`:

cockle-couleurs.dat
 cockle-faces.dat
 cockle-io.dat
 cockle-sommets.dat

8 List of all optional arguments for pst-shell

Key	Type	Default
D	ordinary	1
A	ordinary	25
alpha	ordinary	83
beta	ordinary	42
mu	ordinary	10
Omega	ordinary	30
phi	ordinary	70
a	ordinary	12
b	ordinary	20
L	ordinary	1
P	ordinary	1
W1	ordinary	1
W2	ordinary	1
N	ordinary	0
writedata	boolean	true

References

- [1] Hendri Adriaens. xkeyval package. CTAN:/macros/latex/contrib/xkeyval, 2004.
- [2] Bill Casselman. *Mathematical Illustrations – a manual of geometry and PostScript*. Cambridge University Press, Cambridge, 2005.
- [3] Victor Eijkhout. *T_EX by Topic – A T_EXnician Reference*. DANTE – lehmanns media, Heidelberg/Berlin, 1 edition, 2014.
- [4] Denis Girou. Présentation de PSTricks. *Cahier GUTenberg*, 16:21–70, April 1994.
- [5] Michel Goosens, Frank Mittelbach, Sebastian Rahtz, Denis Roegel, and Herbert Voß. *The L_AT_EX Graphics Companion*. Addison-Wesley Publishing Company, Reading, Mass., 2nd edition, 2007.
- [6] Michel Goosens, Frank Mittelbach, Sebastian Rahtz, Dennis Roegel, and Herbert Voß. *The L_AT_EX Graphics Companion*. Addison-Wesley Publishing Company, Boston, Mass., second edition, 2007.
- [7] Alan Hoenig. *T_EX Unbound: L_AT_EX & T_EX Strategies, Fonts, Graphics, and More*. Oxford University Press, London, 1998.
- [8] Nikolai G. Kollock. *PostScript richtig eingesetzt: vom Konzept zum praktischen Einsatz*. IWT, Vaterstetten, 1989.

-
- [9] Frank Mittelbach and Michel Goossens et al. *The L^AT_EX Companion*. Addison-Wesley Publishing Company, Boston, 2nd edition, 2004.
- [10] Sebastian Rahtz. An introduction to PSTricks, part I. *Baskerville*, 6(1):22–34, February 1996.
- [11] Sebastian Rahtz. An introduction to PSTricks, part II. *Baskerville*, 6(2):23–33, April 1996.
- [12] Herbert Voß. *PSTricks – Graphics and PostScript for L^AT_EX*. UIT, Cambridge – UK, 1. edition, 2011.
- [13] Herbert Voß. *L^AT_EX quick reference*. UIT, Cambridge – UK, 1. edition, 2012.
- [14] Herbert Voß. *Presentations with L^AT_EX*. DANTE – Lehmanns Media, Heidelberg/Berlin, 1. edition, 2012.
- [15] Herbert Voß. *PSTricks – Grafik für T_EX und L^AT_EX*. DANTE – Lehmanns, Heidelberg/Berlin, 7. edition, 2016.
- [16] Timothy Van Zandt. *multido.tex - a loop macro, that supports fixed-point addition*. CTAN:/macros/generic/multido.tex, 1997.
- [17] Timothy Van Zandt and Denis Girou. Inside PSTricks. *TUGboat*, 15:239–246, September 1994.

Index

F

file, 19

K

Keyword

– file, 19

– writedata, 24

M

Macro

– \psShell, 4

P

Package

– pst-solides3d, 20

\psShell, 4

pst-solides3d, 20

W

writedata, 24